



Connected Home Thermostat OpenTherm® RDZ103ZB



[All documentation](#)

en	Mounting instructions
cs	Návod k montáži
el	Οδηγίες τοποθέτησης
fi	Asenusohje
hu	Telepítési leírás
nl	Montage-aanwijzing
pt	Instruções de instalação
ru	Инструкция по установке
sv	Monteringsinstruktion
zh-CN	安装指南

de	Montageanleitung
da	Monteringsvejledning
es	Instrucciones de montaje
fr	Instructions de montage
it	Istruzioni di montaggio
pl	Instrukcja montażu
ro	Instrucțiuni de montaj
sk	Návod na montáž
tr	Montaj talimatları
zh-TW	安裝指南

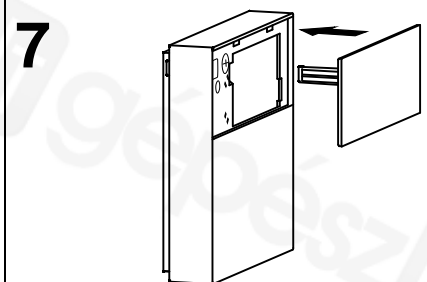
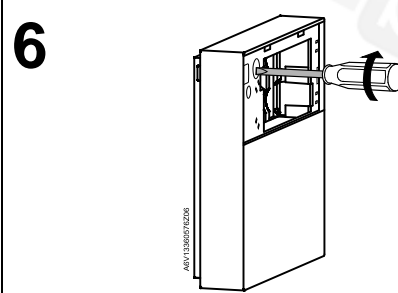
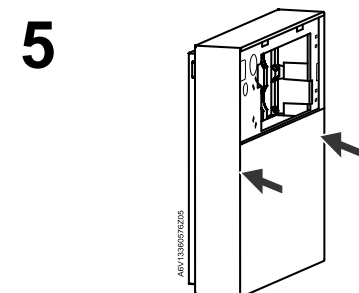
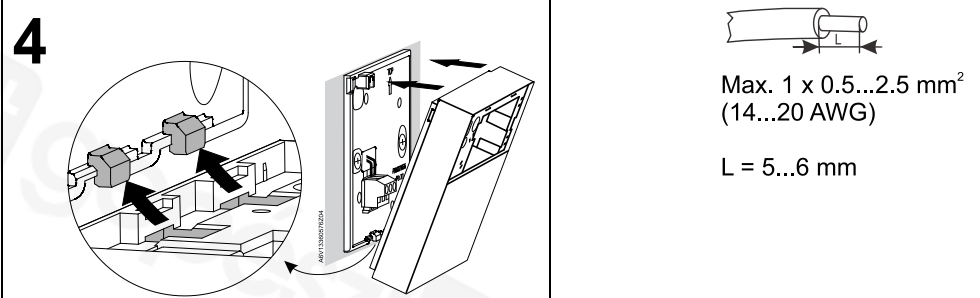
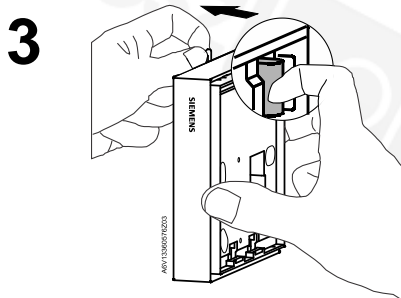
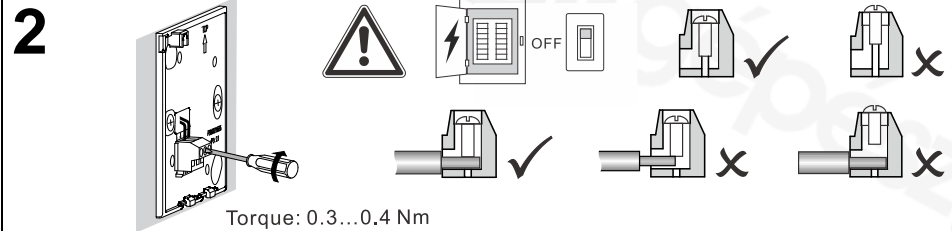
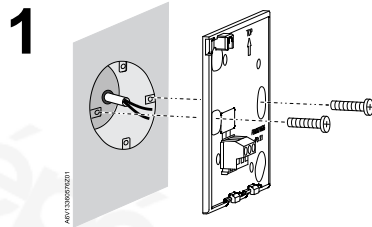
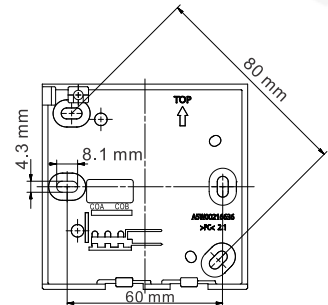
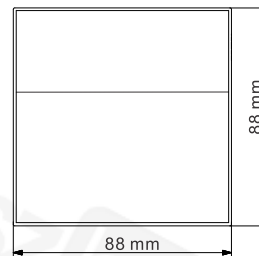
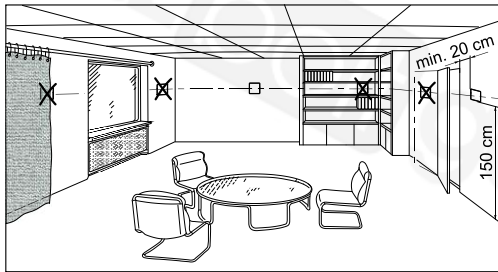

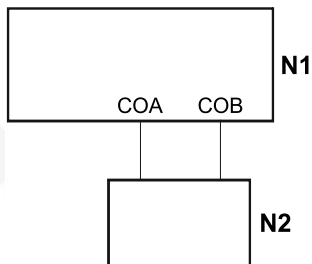
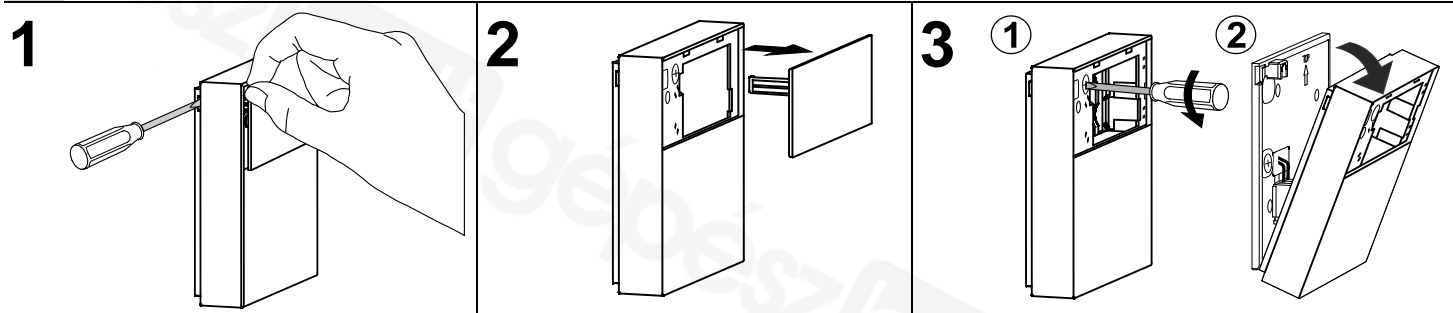

en	
N1	Thermostat RDZ103ZB
N2	Boiler Management Unit (BMU)
COA	OpenTherm contact A (interchangeable)
COB	OpenTherm contact B (interchangeable)

de	
N1	Thermostat RDZ103ZB
N2	Boiler Management (BMU)
COA	OpenTherm Kontakt A (tauschbar)
COB	OpenTherm Kontakt B (tauschbar)

cs	
N1	Termostat RDZ103ZB
N2	Kotel / tepelné čerpadlo
COA	OpenTherm svorka A (zaměnitelná)
COB	OpenTherm svorka B (zaměnitelná)

da	
N1	Termostat RDZ103ZB
N2	Kedelstyring/styreprint
COA	OpenTherm klemme A (ombyttelig)
COB	OpenTherm klemme B (ombyttelig)

el	
N1	Θερμοστάτης RDZ103ZB
N2	Μονάδα διαχείρισης λέβητα
COA	Επαφή Α για OpenTherm (χωρίς πολικότητα)
COB	Επαφή Β για OpenTherm (χωρίς πολικότητα)

es	
N1	Termostato RDZ103ZB
N2	Unidad de Gestión de Calderas (BMU)
COA	Contacto OpenTherm A (intercambiable)
COB	Contacto OpenTherm B (intercambiable)

fi	
N1	Termostaatti RDZ103ZB
N2	Varaajan hallintalaite (BMU)
COA	OpenTherm liitäntä A (vaihdettavissa)
COB	OpenTherm liitäntä B (vaihdettavissa)

fr	
N1	Thermostat RDZ103ZB
N2	Unité de gestion de chaudière (BMU)
COA	OpenTherm contact A (interchangeable)
COB	OpenTherm contact B (interchangeable)

hu	
N1	Termostát RDZ103ZB
N2	Kazán vezérlő egység
COA	OpenTherm terminál A (felcserélhető)
COB	OpenTherm terminál B (felcserélhető)

it	
N1	Termostato RDZ103ZB
N2	Caldaia / dispositivo Open Therm
COA	Morsetto A OpenTherm (intercambiabile)
COB	Morsetto B OpenTherm (intercambiabile)

nl	
N1	Thermostaat RDZ103ZB
N2	Cv-Ketel
COA	OpenTherm contact A (verwisselbaar)
COB	OpenTherm contact B (verwisselbaar)

pl	
N1	Termostat RDZ103ZB
N2	Jednostka zarządzania kotłem (BMU)
COA	OpenTherm zacisk A (zamienny)
COB	OpenTherm zacisk B (zamienny)

pt	
N1	Termostato RDZ103ZB
N2	Unidade de gestão da caldeira (BMU)
COA	OpenTherm contacto A (intercambiável)
COB	OpenTherm contacto B (intercambiável)

ro	
N1	Termostat RDZ103ZB
N2	Unitatea de management al cazanului (BMU)
COA	Contact OpenTherm A (interschimbabil)
COB	Contact OpenTherm B (interschimbabil)

ru	
N1	Термостат RDZ103ZB
N2	Блок управления котлом (BMU)
COA	Контакт OpenTherm A (взаимозаменяемые)
COB	Контакт OpenTherm B (взаимозаменяемый)

sk	
N1	Termostat RDZ103B
N2	Riadiaca jednotka kotla (BMU)
COA	OpenTherm kontakt A (zameniteľné)
COB	OpenTherm kontakt B (zameniteľné)

sv	
N1	Termostat RDZ103ZB
N2	Betjäningssenhets
COA	OpenTherm plint A (växlingsbar)
COB	OpenTherm plint B (växlingsbar)

tr	
N1	Termostat RDZ103ZB
N2	Kazan Yönetim Ünitesi
COA	OpenTherm (açık terminal) terminali A
COB	OpenTherm (açık terminal) terminali B

zh-CN	
N1	房间温控器 RDZ103ZB
N2	锅炉管理单元 (BMU)
COA	OpenTherm 触点 A (可互换)
COB	OpenTherm 触点 B (可互换)

zh-TW	
N1	房間溫控器 RDZ103ZB
N2	鍋爐管理單元 (BMU)
COA	OpenTherm 觸點 A (可互換)
COB	OpenTherm 觸點 B (可互換)